

# MiiCraft Ultra series

150/125/100/80/50/100X  
3D Printer

## User Manual for Hardware

Version 1.0



## Content

1 Product Information-----	3
1.1 Instructions for Use-----	3
1.2 Regulatory Statements-----	3
1.3 Safety Precautions-----	4
1.4 General Information-----	5
1.5 Package Contents-----	5
1.6 Product Overview-----	6
2 Set up your 3D printer -Hardware-----	7
2.1 Unpack-----	7
2.2 Connect Computer-----	7
2.3 Power Button Control-----	8
2.4 Install Picker-----	9
2.5 Fill Resin Tank-----	9
3 Operate your 3D printer -Software-----	10
4 After Print-----	10
4.1 Remove Model-----	10
4.2 Clean Picker-----	10
4.3 Clean Resin Tank-----	10
Appendix 1. Specifications-----	11
Appendix 2. Resin Curing Time-----	12
Appendix 3. Printing Parameter-----	12
Appendix 4. Indoor Air Quality Evaluation Summary-----	13

# 1 Product Information

## 1.1 Instructions for Use

Please read through the following **Instructions** before you start using your printer.

(1) Ensure that the glass under tank is positioned flat at the corners point, for not damaging printer while printing.

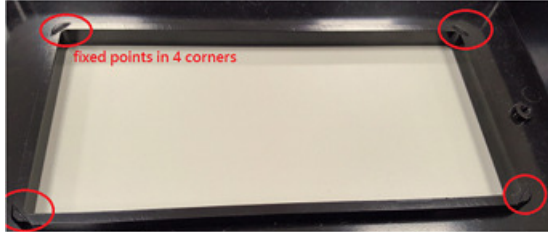

(2) Ensure no residuals inside the tank and the glass is well setup before printing.

(3) Avoid print at center point with a single object or small parts repeatedly, it may damage the tank.

## 1.2 Regulatory Statements

### FCC NOTICE

This equipment has been tested and found to comply with the limits for a class "A" digital device, pursuant to Part 15 of the FCC Rules.

These limits are designed to provide reasonable protection against harmful interference. This equipment generates, uses, and can radiate radio frequency energy and, if not installed and used in accordance with the instruction manual, may cause harmful interference to radio communications. Operation of this equipment in a residential area is likely to cause harmful interference in which case the user will be required to correct the interference at their expense.

### SAFETY CERTIFICATION

This equipment has been tested and compliance to safety requirement.



### INDOOR AIR QUALITY Evaluation

This equipment has passed INDOOR AIR QUALITY Evaluation base on **UL2819** Standard. Please see appendix 4.

### 1.3 Safety Precautions

Please read through the following Safety Precautions before you start using your printer.



- (1) Use only the power adapter and accessories provided by the manufacturer.
- (2) Before plugging the power adapter into an electrical outlet, verify the local power rating conforms with the specified voltage and frequency.
- (3) This printer needs a grounded, 1-phase electrical power source.
- (4) Make sure power and communication cables are well managed to prevent from tripping.
- (5) Only use resins supplied by MiiCraft manufacturer. Use of other unauthorized resins may cause printing failure.
- (6) Do not expose the resin tank to direct light source because the resin will solidify under UV light.
- (7) Chemical substances like resin may cause skin irritation, please read the guidelines in Material Safety Data Sheet (MSDS) of the resin supplied by manufacturer. It is recommended to wear gloves when necessary.
- (8) When moving the printer for a long distance, be sure to withdraw the remaining resin in reaction tank and clean the tank in advance to prevent from resin overflow.
- (9) Keep doors closed during printing or curing to prevent UV leakage.
- (10) UV light may cause injury of eyes, do not stare into the printer directly when it is in operation. It is recommended to wear UV protective glasses during operating the printer.
- (11) Place the device on a level surface and keep the printer in an upright position at all times.
- (12) Do not store the printer in extreme hot and cold temperatures.
- (13) Do not disassemble or repair the device yourself. Doing so may cause device malfunction or danger.
- (14) Warning :Picker is hazardous moving parts in MiiCraft Printer. Keep body parts out of picker's motion path.
- (15) Emergency shut down method : Press the power button to "Power down" mode, then press and hold the power button for 2 seconds to shut down. And press power button again to turn on the printer, the picker will turn to original position.

1.3 General Information

Product Name	MiiCraft 150/125/100/80/50/100X
Power Input	Printer : 24V DC, 3.75A With Adapter : 100~240V AC, 2A, 50/60Hz
Net Weight	37.5 kg
Package Size and Weight	80x80x94 cm / 58 kg (Including pallet)
Operating Temperature	10° to 30°
Humidity (RH)	40% to 60% Our printer should keep in dry conditions
Storage of Printing Material	Store the materials at ambient temperature from 15° to 28° And do not exposure to the light, otherwise resin may solidified

- Liability: In case you do not follow the operating manual we cannot be held responsible for damages of the machine or injuries on the operator.
- Repair can only be carried out by authorized person of MiiCraft.

1.4 Package Contents

There is a printer and an accessory box inside the package. As soon as you receive our products, please verify its content and check if there's any exterior damage due to transportation.

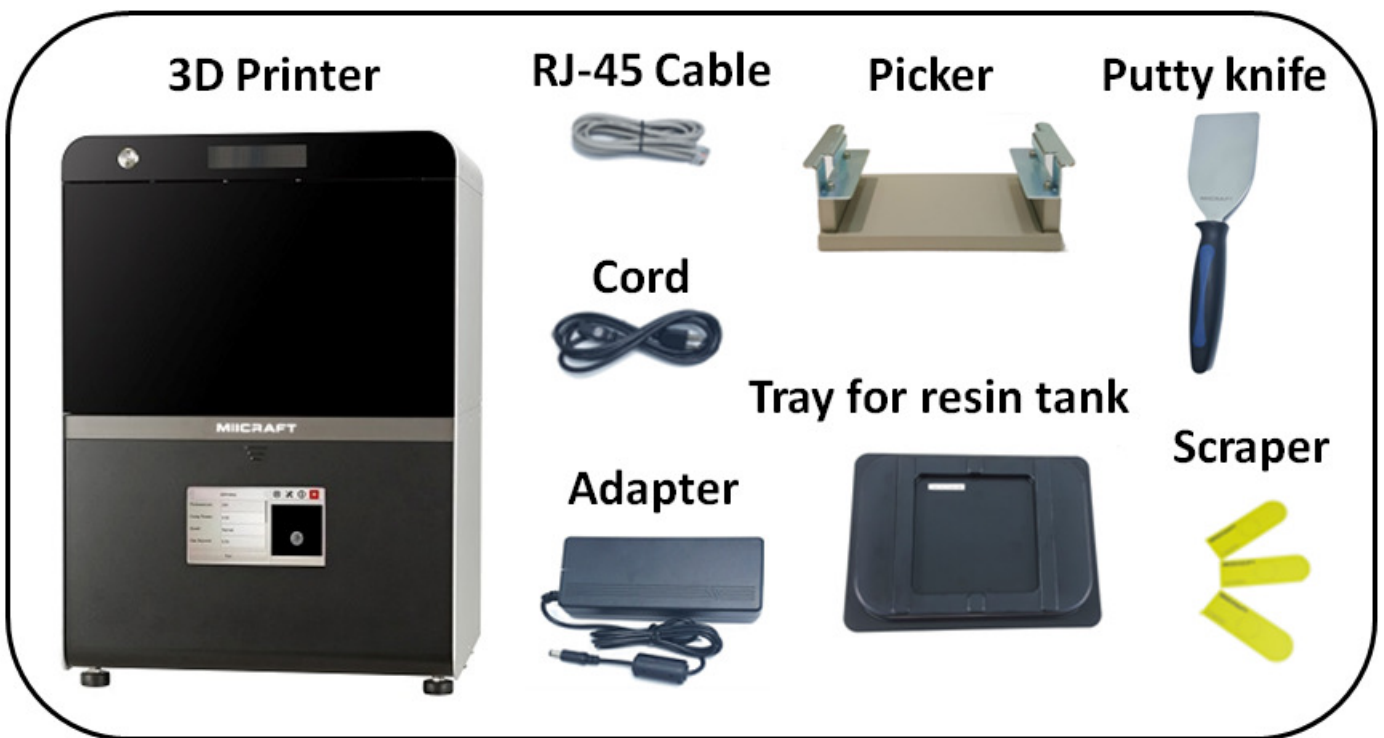

1.6 Product Overview

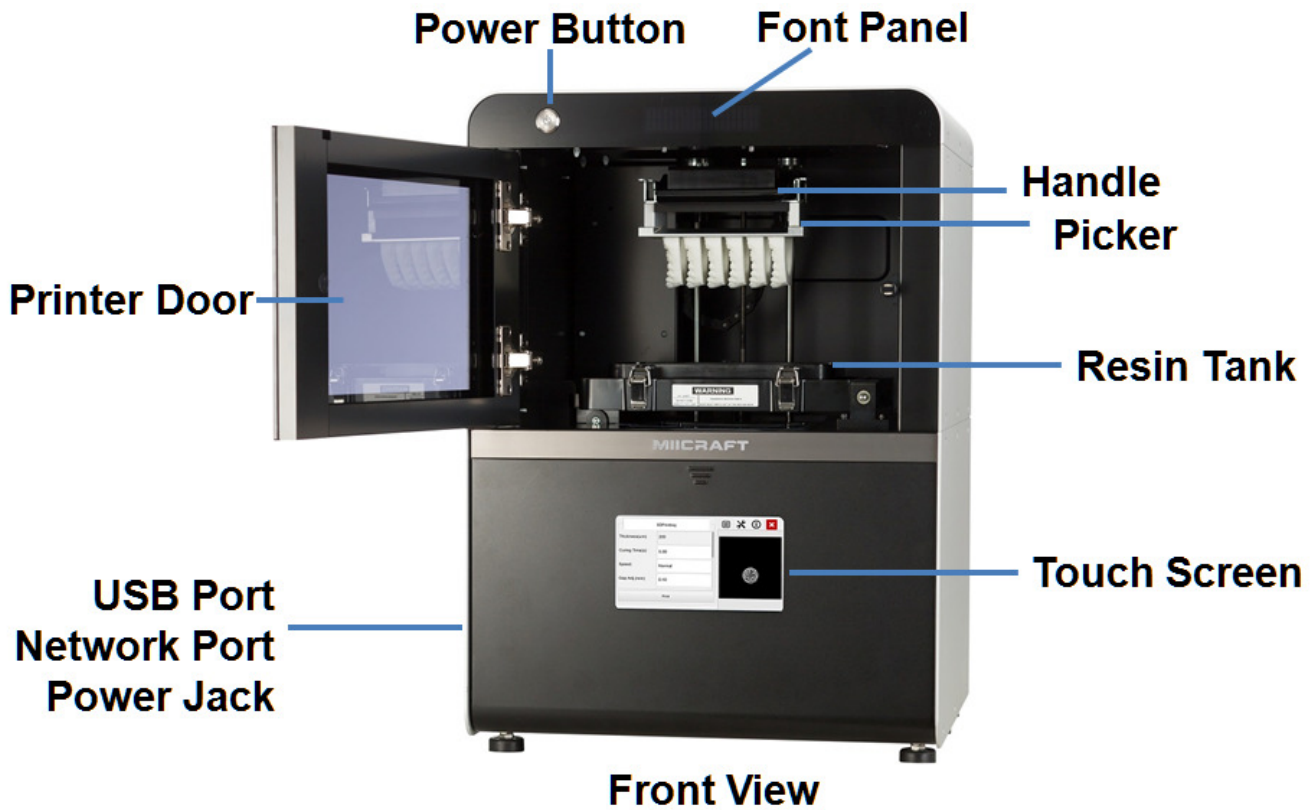

## 2 Setting up your 3D printer - Hardware

### 2.1 Unpack

(1) Remove the top cardboard

(2) Remove the EPE surround the inner box

(3) Remove the side cardboard

(4) Remove the inner box



**WARNING** Printer net weighs 37.5kg. Please be careful, and use proper lifting techniques to avoid injury.

### 2.2 Connecting to the Power adapter and Cable



(1) Connect the power cord and adapter to your device, and then plug it into an electrical outlet

(2) Connect your printer with laptop

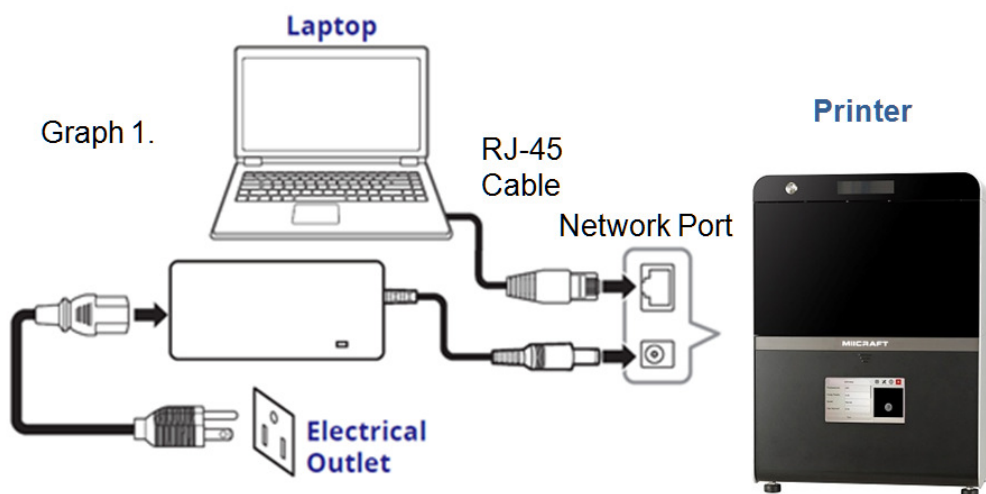
- Basic : Connect printer and laptop by RJ-45 cable (Graph1.) [Initiating time 1 minute ]
- LAN : Connect both printer and laptop to local area network [Initiating time a few seconds ]
- IP sharer : Connect both printer and laptop to IP sharer [Initiating time a few seconds ]



### 2.3 Power Button Control

Purple		Blinking	System warms up
Blue		Solid	Standby mode
		Blinking	Printing in progress
Red		Solid	Error

Besides Power on and off, you can use Power button to select file in USB to print. Or download the latest firmware from our website, and execute firmware upgrade by USB.

- Press power button : change mode in the same level
- Pressed and Hold power button : hold down the power button for up to 2 seconds to enter the next level
- Emergency shut down method : Press the power button to "Power down" mode, press and hold the power button for 2 seconds to shut down. And press power button again to turn on the printer, the picker will turn to original position.

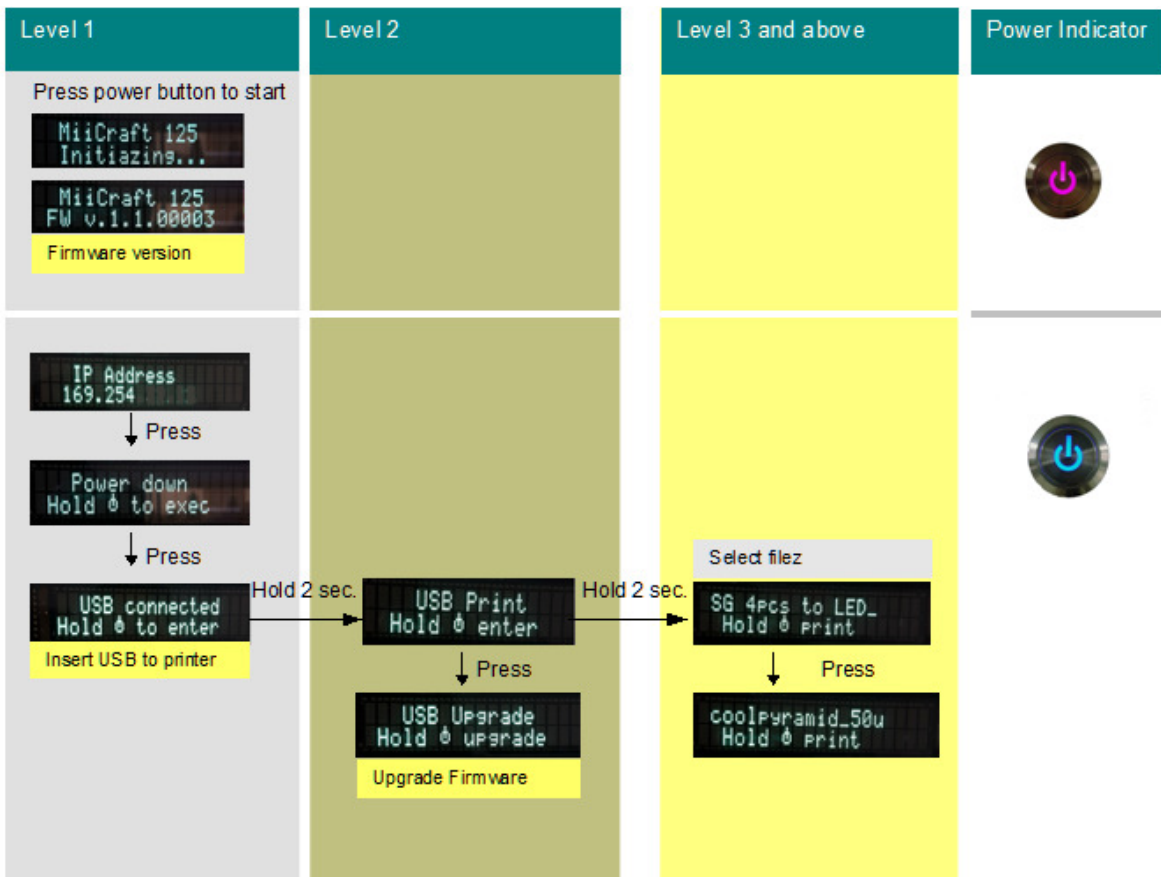

※ Download the latest firmware from <http://www.mii-craft.com/support/> to your USB first. Save as .ZIP file, and select it for upgrade



## 2.4 Touch Screen Control

### (1) Select file & Print:

Input .mii file through USD port, the printing parameters will automatically apply the same one in MiiUtility.

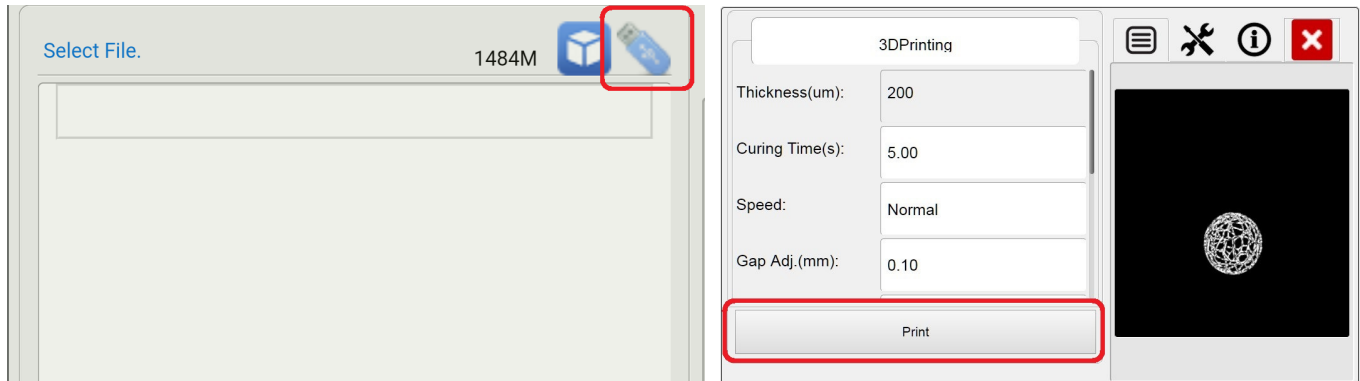

File input limitation from USB: 1GB

The printing setting is same as printing setting interface in MiiUtility (See page 14 in user guide of MiiUtility).

### (2) Engineering Mode

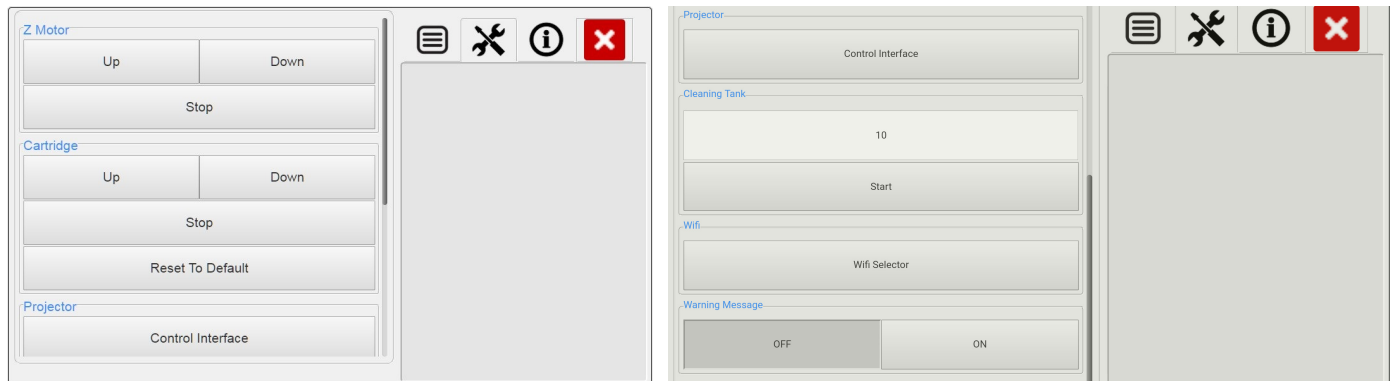

Test module	Action Item	Verifying Correct Module Behavior
Z Motor	Up	The Z-platform moves upwards.
	Down	The Z-platform moves downwards.
	Stop	The movement stops.
Cartridge	Up	The cartridge moves upwards.
	Down	The cartridge moves downwards.
	Stop	The cartridge stops.
	Reset	The cartridge moves to default height.

Projector	Control Interface	<p>On/Off : Turn on or Off the projector</p> <p>T1/T2/T3 : Use test pattern inside the projector, or select a pattern from menu</p> <p>Pattern menu : From 01 to 09 are more choices of test patterns. Pattern No.10 can test the wire connection or its availability</p> <p>Uniformity Mask: Tick this option to apply printer calibration function</p> <p>Light(%): At 100% is the existing brightness of light engine. User can set higher brightness or lower brightness for test printing</p> <p>Calibrate: Reset to original brightness (default setting)</p>
Cleaning Tank	Start	<p>1) Project a complete pattern to tank, the residue will be transformed into a solid layer. 2) Using the scraper, scoop up one side of the layer. Then carefully lift to remove the layer from the tank.</p>
Wifi	Wifi Selector	<p>-Click Wifi selector</p> <p>-Search and link to available AP</p> <p>*Only the first time using Wifi dongle, you need cable/LAN/IP sharer to connect printer and laptop. After then, just insert the Wifi dongle to enjoy wireless control</p>
Warning Message	OFF/ ON	<p>Message to reminder pulling down picker handle</p>

### 2.5 Install Picker

Carry both end of picker and install it onto the machine

1



Put down the handle to lock the Picker

2

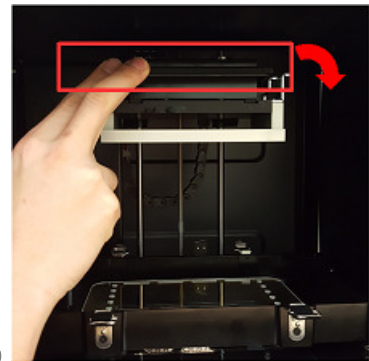

Handle

※ Remove the Picker: Lift the handle→Carry both end of picker→Remove the Picker

### 2.6 Fill resin tank

Unlock the Resin tank from four corners

1

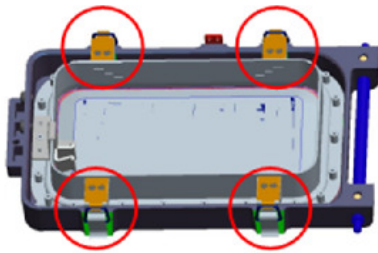

Pick up the resin tank

2

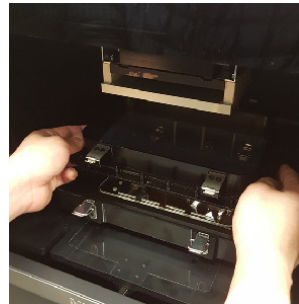

Pour resin

3



※ Remember to lock four corners of resin tank after install it.

※ EPE has to be removed before First printing

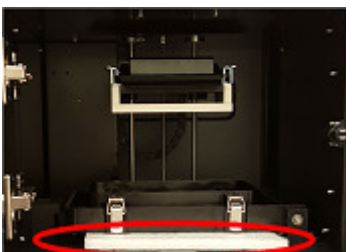

## 3 Operate your 3D printer –Software

Please refer to MiiUtility User Manual, all-in-one software for MiiCraft printers.

## 4 After Print

### 4.1 Remove Model

Lift the handle→Remove the Picker and printed model→Use air gun and ethanol to clean the printed model →Post curing (Additional post curing unit is required)→Carefully remove the printed model from the picker. → Use putty knife to help separate the printed model and picker

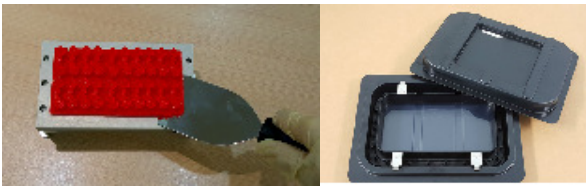

\* Do not expose the resin tank to direct light source because the resin will solidify under UV light. Use tray to cover the resin tank to prevent solidify.

### 4.2 Clean Picker

Use putty knife or similar object to scrape away the excess printed model on the picker. If any greasy residue persists, use a soft cloth dipped in alcohol to rub the surface until the grease is removed.

### 4.3 Clean Resin Tank

Pour resin out of tank→ Pour ethanol into tank and soak in a while→ Use tissue or lens tissue softly wipe the bottom of tank→ Finished cleaning. Or let the projector help cleaning Tank, please refer to MiiUtility user manual, the cleaning Tank Process on Page 20.















#### Notifications:

- Do not shut down the power during curing
- Do not interrupt the firmware upgrade process. Any interruptions during the firmware upgrade process may cause your printer to malfunction.
- Update the firmware frequently for better user experience, please refer to page8, page14 for upgrade
- Before printing, please check the surface of picker and tank is clean, no residual, or may affect printing quality.
- Tank and Picker are consumables, suggest replace for a period, or may affect printing quality.
- Tank has lifespan around 1,000 hours. Evenly arrange the printing model can protect the tank, do not print on one single point repeatedly.







## Appendix 1. Specifications

Category	Item	MiiCraft 150*	MiiCraft 125*	MiiCraft 100*	MiiCraft 80*	MiiCraft 50*
Printing Area	Max. Building Size (mm)	150x84.4x120	125x70x120	102x57.5x120	80x45x120	57x32x120
	XY Resolution	78um	65 μm	53 μm	41.5 μm	30 μm
	Z-axis Layer Thickness	5~ 200 μm				
Lighting	Wavelength	*=Space for 405nm/ *=X for 365nm / *=Y for 385nm LED				

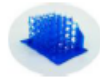
Category	Item	Specification
Operating Environment	Temperature	10°C to 30°C
	Humidity (RH)	40% to 60%
Safety	Certification	CE, FCC, UL, KC, CB, WEEE
Software	Operating System	Windows7 , Windows8, Windows10
	Network Browser	Google Chrome
	File Input	.SLC, .STL
	File Input limitation	MiiController file input limitation from PC: 130MB MiiController file input limitation from USB: 1GB
System Properties	Printer Size (LxWxH)	43x 43x 59 cm
	Weight	37.5 kg
	Interface	Ethernet Connection · USB (Direct Printing)
	Power Input	Printer : 24V DC, 3.75A With Adapter :100~240V AC, 2A, 50/60Hz
	Packaged size and weight	80x80x94 cm / 58 KG (Including pallet)
Printing Material	Model Printing	    BV001 BV002 BV004 BV005
	Castable	  BV011 BV012
	Research	       BV003 BV007 Cyan/Yellow/Magenta/Black/White *5 Colors of Nano-colorants are Available with BV003

\*\*All Specifications & Designs subject to change without notice.

## Appendix 2. Resin curing time

BRAND	TYPE	LAYER	MiiCraft NVP+ 405nm	MiiCraft 125 405nm	PROPERTIES	IMAGE
<b>Mii</b> craft	BV001 (Cream)	100um	7.00	1.30~1.50	Standard resin and most cost effective Application for all model	
		50um	4.50			
		30um				
	BV002 (Dark blue)	100um	7.00	1.30~1.50	Standard resin and most cost effective Application for all model	
		50um	4.50			
		30um				
	BV003 (Clear)	100um	6.50	1.05~1.25	Transparent resin and fine performance Application for all model	
		50um	4.50			
30um						
BV004 (Pink)	100um	7.00	1.30~1.50	High stability resin and most cost effective Application for dental model		
	50um	4.50				
	30um					
BV005 (Ivory)	100um	7.00	1.30~1.50	High stability resin and most cost effective Application for dental model		
	50um	4.50				
	30um					
BV007 (Clear)	100um	8.50	1.40~1.60	Low viscosity resin and smallest microchannels Application for 3D microfluidic devices		
	50um	4.50				
	30um					
BV011 (Palegreen)	100um	7.00	1.30~1.50	Dental castable resin Application for fast investment casting		
	50um	5.00				
	30um					
BV012 (Orange)	100um		2.10~2.50	Jewelry castable resin Application for direct investment casting		
	50um	6.00				
	30um	3.50				

Material List NO.2016.06.04

More material test will be completed and added into this list in the near future since the experiments.  
Please follow our newest result and keep the list NO. up to date.

## Appendix 3. Printing Parameter

Download printing parameter from our website:

<http://www.mii-craft.com/support/printing-parameter/>



## Appendix 4. Indoor Air Quality Evaluation Summary



### INDOOR AIR QUALITY EVALUATION SUMMARY

UL Environment performed an indoor air quality (IAQ) evaluation of "Model Name: 3D Printer; Model No.: MiiCraft 125" for Young Optics, Inc. UL Environment conducted this study using the UL 2819 Standard, USEPA ETV protocol for office equipment, ASTM Standards D 6670, and ISO/IEC 28360. As a part of the evaluation, an indoor air quality (IAQ) exposure assessment was completed on the volatile organic compound (VOC) and ozone emissions. The comprehensive assessment is included in UL Report 18680-01.

The unit was tested for emissions of VOCs and ozone in a dynamic environmental chamber over an 8-hour time period and resulting emission data were used to estimate room air concentrations. Predicted indoor concentration levels of all identified VOCs; including aldehydes, and ozone for given use conditions of the monitor were screened for compliance with key regulatory requirements and the potential to result in adverse health effects.

For the quantitative risk assessment, exposure parameters included continuous 8-hour workday exposure for an estimated 7-year life span for the product. These results are also based only on inhalation exposure and do not consider other potential routes of exposure, such as dermal and ingestion. In addition only those VOCs, primarily C6 - C16 hydrocarbons that can be measured by the specific analytical methods are reported. Predicted exposure data should be evaluated with expert counsel relative to use and Proposition 65 labeling regulations.

#### Results Summary<sup>†</sup>

Requirement	Passes Requirements?
1. Estimated room concentrations of select contaminants are below recommended or regulated occupational exposure limits (ACGIH TLVs, AIHA WEELs, OSHA PELs)	Yes
2. Predicted inhalation exposures of identified Proposition 65 chemicals are below applicable NSRL and MADL criteria under the defined exposure usage.	Yes
3. Predicted inhalation exposures of select contaminants are below Acute and Chronic Reference Exposure Levels as established by the State of California.	Yes
4. Results of health risk assessment showed that estimated exposure concentrations resulting from the product are below critical inhalation toxicity values for chronic cancer/non-cancer effects based on defined USEPA and ATSDR proposal levels.	Yes

<sup>†</sup>Assessment results are based only on the test and exposure parameters as defined in this report. These results are also based only on inhalation exposure and do not consider other potential routes of exposure, such as dermal and ingestion. In addition only those VOCs, primarily C<sub>6</sub> - C<sub>16</sub> hydrocarbons, that can be measured by the specific analytical methods are reported. Predicted exposure data results are estimated and should be evaluated with expert counsel relative to use and Proposition 65 labeling regulations.

W. Elliott Horner, PhD  
Lead Scientist  
Data and Risk Analysis

Stephanie Schiller  
Quality Assurance Manager

Allyson McFry  
Chemistry Laboratory Director  
Chemical Analysis